

- CAUTION**
- The communicator should be installed and maintained by qualified personnel.
 - Prior to installation, it is advised to read full device installation manual carefully in order to avoid mistakes that can lead to malfunction or even damage the equipment.
 - Disconnect the power supply before making any electrical connections.
 - Changes, modifications or repairs not authorized by the manufacturer shall void your rights under the warranty.

Schematics for wiring the communicator to the security control panel

Following the schematics provided below, wire the communicator to the control panel.

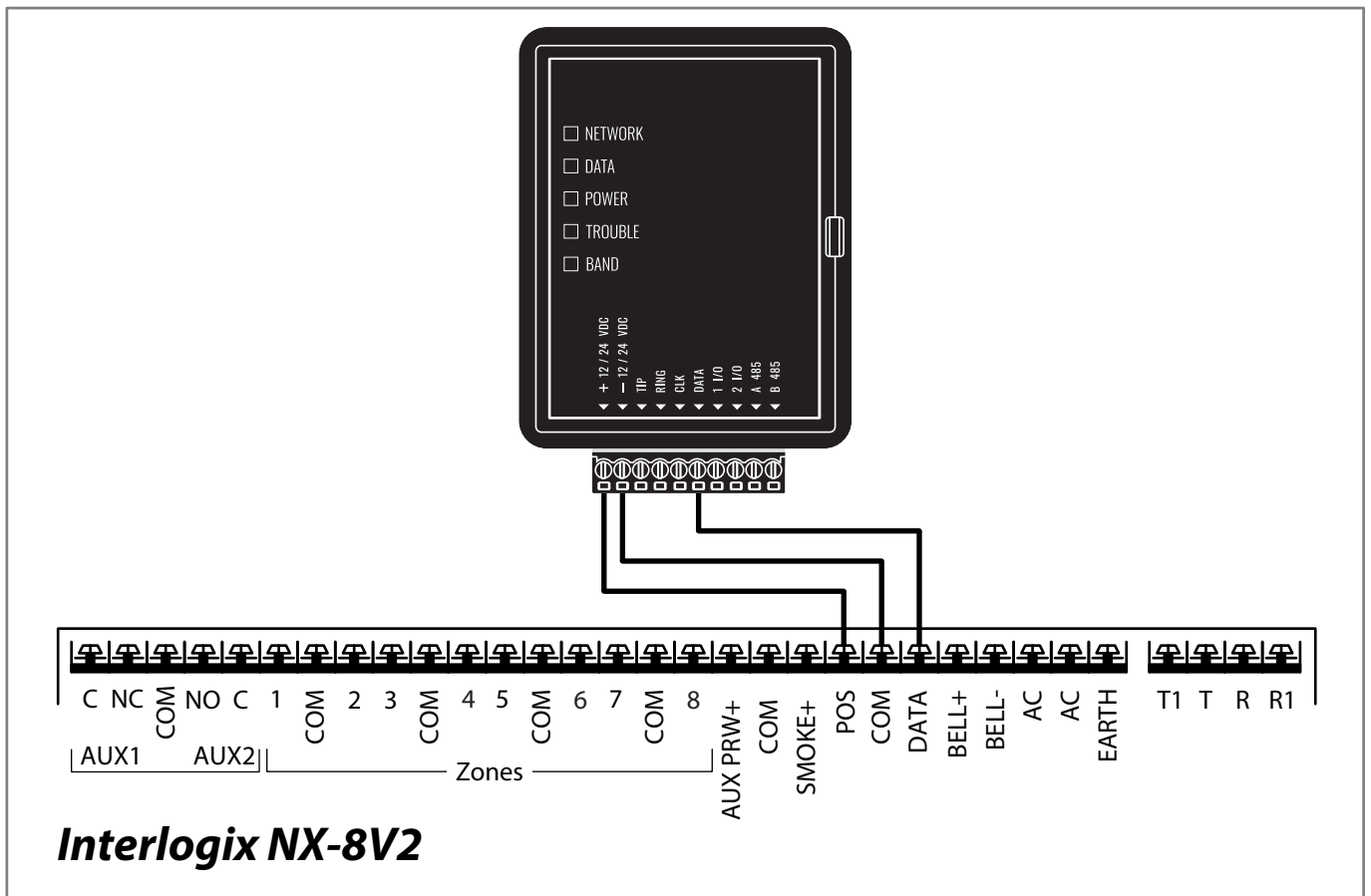

Programming the Interlogix NX-8V2 Alarm Panel via the LCD Keypad

Using the control panel's keypad enter these sections and set them as described:

Enable Contact ID reporting

LCD keypad	Keypad Entry	Action Description
System ready	*89713	Enter programming mode
Enter device address	0#	To go to main panel programming menu
Enter location	4#	To go to "Phone1 events reported" toggle menu.
Loc#4 Seg#1	12345678*	All toggle options should be enabled. * to save and go to next menu.
Loc#4 Seg#2	12345678*	All toggle options should be enabled. * to save and go back.
Enter location	23#	To go to "Partition features" menu.
Loc#23 Seg#1	**	Press * twice to go to section 3 toggle options menu.
Loc#23 Seg#3	12345678*#	Segment 3. All toggle options should be enabled, press * to save and then # to save and # to go back to the main menu.
Enter location	37#	To go to "Siren and system supervision" menu.
Loc#37 Seg#1	**	Press * twice to go to segment 3 toggle options menu.
Loc#37 Seg#3	12345678*	Segment 3. All toggle options should be enabled, press * to save.
Loc#37 Seg#4	12345678*#	Segment 4. All toggle options should be enabled, press * to save and then # to save and # to go back to the main menu.
Enter location	90#	To go to "Partition 2 features" menu.
Loc#90 Seg#1	**	Press * twice to go to section 3 toggle options menu.
Loc#90 Seg#3	12345678*#	Segment 3. All toggle options should be enabled, press * to save and then # to save and # to go back to the main menu.
Enter location	93#	To go to "Partition 3 features" menu.
Loc#93 Seg#1	**	Press * twice to go to section 3 toggle options menu.
Loc#93 Seg#3	12345678*#	Segment 3. All toggle options should be enabled, press * to save and then # to save and # to go back to the main menu.

Programming the Interlogix NX-8V2 Alarm Panel via the LCD Keypad

Using the control panel's keypad enter these sections and set them as described:

Enable Contact ID reporting

LCD keypad	Keypad Entry	Action Description
Enter location	96#	To go to "Partition 4 features" menu.
Loc#96 Seg#1	**	Press * twice to go to section 3 toggle options menu.
Loc#96 Seg#3	12345678*#	Segment 3. All toggle options should be enabled, press * to save and then # to save and # to go back to the main menu.
Enter location	99#	To go to "Partition 5 features" menu.
Loc#99 Seg#1	**	Press * twice to go to section 3 toggle options menu.
Loc#99 Seg#3	12345678*#	Segment 3. All toggle options should be enabled, press * to save and then # to save and # to go back to the main menu.
Enter location	102#	To go to "Partition 6 features" menu.
Loc#102 Seg#1	**	Press * twice to go to section 3 toggle options menu.
Loc#102 Seg#3	12345678*#	Segment 3. All toggle options should be enabled, press * to save and then # to save and # to go back to the main menu.
Enter location	105#	To go to "Partition 7 features" menu.
Loc#105 Seg#1	**	Press * twice to go to section 3 toggle options menu.
Loc#105 Seg#3	12345678*#	Segment 3. All toggle options should be enabled, press * to save and then # to save and # to go back to the main menu.
Enter location	108#	To go to "Partition 8 features" menu.
Loc#108 Seg#1	**	Press * twice to go to section 3 toggle options menu.
Loc#108 Seg#3	12345678*#	Segment 3. All toggle options should be enabled, press * to save and then # to save and # to go back to the main menu.
Enter location	EXIT EXIT	Press "EXIT" twice to exit programming mode.

Programming the Interlogix NX-8V2 Alarm Panel via the LED Keypad

Using the control panel's keypad enter these sections and set them as described:

Enable Contact ID reporting

LED keypad	Keypad Entry	Action Description
LEDs of Ready, Power steady ON	*89713	Enter programming mode
Service LED blinks	0#	To go to main panel programming menu
Service LED blinks, Armed LED steady ON	4#	To go to "Phone1 events reported" toggle menu.
All zone LEDs are ON	12345678*	All toggle options should be enabled. * to save and go to next menu.
All zone LEDs are ON	12345678*	All toggle options should be enabled. * to save and go back.
Service LED blinks, Armed LED steady ON	23#	To go to "Partition feature and reporting selection" menu.
Service LED blinks, Ready LED steady ON	**	Press * twice to go to segment 3 toggle options menu.
Service LED blinks, Ready LED steady ON	12345678*#	Segment 3. All toggle options should be enabled, press * to save and then # to save and # to go back to the main menu.
Service LED blinks, Armed LED steady ON	37#	To go to "Siren and system supervision" menu.
Service LED blinks, Ready LED steady ON	**	Press * twice to go to segment 3 toggle options menu.
Service LED blinks, Ready LED steady ON	12345678*	Segment 3. All toggle options should be enabled, press * to save.
Service LED blinks, Ready LED steady ON	12345678*#	Segment 4. All toggle options should be enabled, press * to save and then # to save and # to go back to the main menu.
Service LED blinks, Armed LED steady ON	90#	To go to "Partition 2 feature and reporting selection" menu.
Service LED blinks, Ready LED steady ON	**	Press * twice to go to segment 3 toggle options menu.
Service LED blinks, Ready LED steady ON	12345678*#	Segment 3. All toggle options should be enabled, press * to save and then # to save and # to go back to the main menu.
Service LED blinks, Armed LED steady ON	93#	To go to "Partition 3 feature and reporting selection" menu.
Service LED blinks, Ready LED steady ON	**	Press * twice to go to segment 3 toggle options menu.
Service LED blinks, Ready LED steady ON	12345678*#	Segment 3. All toggle options should be enabled, press * to save and then # to save and # to go back to the main menu.

Programming the Interlogix NX-8V2 Alarm Panel via the LED Keypad

Using the control panel's keypad enter these sections and set them as described:

Enable Contact ID reporting

LED keypad	Keypad Entry	Action Description
Service LED blinks, Armed LED steady ON	96#	To go to "Partition 4 feature and reporting selection" menu.
Service LED blinks, Ready LED steady ON	**	Press * twice to go to segment 3 toggle options menu.
Service LED blinks, Ready LED steady ON	12345678*#	Segment 3. All toggle options should be enabled, press * to save and then # to save and # to go back to the main menu.
Service LED blinks, Armed LED steady ON	99#	To go to "Partition 5 feature and reporting selection" menu.
Service LED blinks, Ready LED steady ON	**	Press * twice to go to segment 3 toggle options menu.
Service LED blinks, Ready LED steady ON	12345678*#	Segment 3. All toggle options should be enabled, press * to save and then # to save and # to go back to the main menu.
Service LED blinks, Armed LED steady ON	102#	To go to "Partition 6 feature and reporting selection" menu.
Service LED blinks, Ready LED steady ON	**	Press * twice to go to segment 3 toggle options menu.
Service LED blinks, Ready LED steady ON	12345678*#	Segment 3. All toggle options should be enabled, press * to save and then # to save and # to go back to the main menu.
Service LED blinks, Armed LED steady ON	105#	To go to "Partition 7 feature and reporting selection" menu.
Service LED blinks, Ready LED steady ON	**	Press * twice to go to segment 3 toggle options menu.
Service LED blinks, Ready LED steady ON	12345678*#	Segment 3. All toggle options should be enabled, press * to save and then # to save and # to go back to the main menu.
Service LED blinks, Armed LED steady ON	108#	To go to "Partition 8 feature and reporting selection" menu.
Service LED blinks, Ready LED steady ON	**	Press * twice to go to segment 3 toggle options menu.
Service LED blinks, Ready LED steady ON	12345678*#	Segment 3. All toggle options should be enabled, press * to save and then # to save and # to go back to the main menu.
Service LED blinks, Armed LED steady ON	EXIT EXIT	Press "EXIT" twice to exit programming mode.

LED indication of communicator operation

Indicator	Light status	Description
NETWORK	Off	No connection to cellular network
	Yellow blinking	Connecting to cellular network
	Green solid with yellow blinking	Communicator is connected to cellular network. Yellow blinks count indicates signal strength, 10 blinks max. Sufficient cellular signal strength for 4G network - level 3 (three yellow flashes).
DATA	Off	No unsent events
	Green solid	Unsent events are stored in buffer
	Green blinking	(Configuration mode) Data is being transferred to/from communicator
POWER	Off	Power supply is off or disconnected
	Green solid	Power supply is on with sufficient voltage
	Yellow solid	Power supply voltage is insufficient ($\leq 11.5V$)
	Green solid and yellow blinking	(Configuration mode) Communicator is ready for configuration
	Yellow solid	(Configuration mode) No connection with computer
TROUBLE	Off	No operation problems
	1 red blink	SIM card not found
	2 red blinks	SIM card PIN code problem (incorrect PIN code)
	3 red blinks	Programming problem (No APN)
	4 red blinks	Registration to GSM network problem
	5 red blinks	Registration to GPRS/UMTS network problem
	6 red blinks	No connection with the receiver
	7 red blinks	Lost connection with control panel
	8 red blinks	The entered ICCID number does not match the ICCID number of the SIM card
	Red blinking	(Configuration mode) Memory fault
	Red solid	(Configuration mode) Firmware is corrupted
BAND	1 green blink	None
	2 green blinks	GSM
	3 green blinks	GPRS
	4 green blinks	EDGE
	5 green blinks	HSDPA, HSUPA, HSPA+, WCDMA
	6 green blinks	LTE TDD, LTE FDD

Setting up the GT+ communicator with the app

Download and launch the Protegus application or use the browser version: **web.protegus.app**.
The installer must connect to Protegus with an installer account.

Step 1



Click the "Add new system" button

Step 2

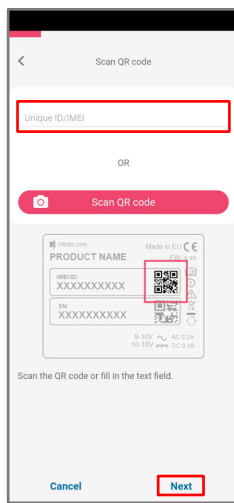

Enter the IMEI number of the communicator

Step 3

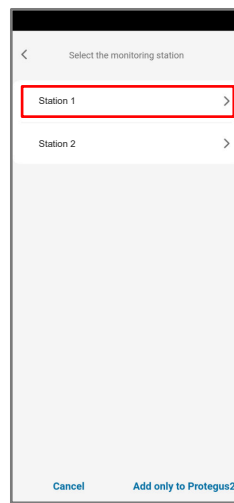

Select security company

Step 4

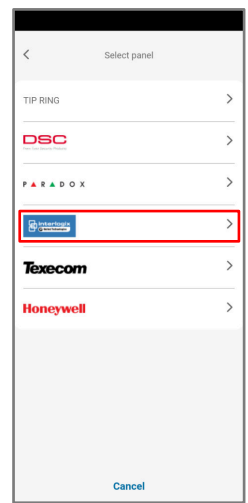

Press "Interlogix"

Step 5



Press "NX-8"

Step 6

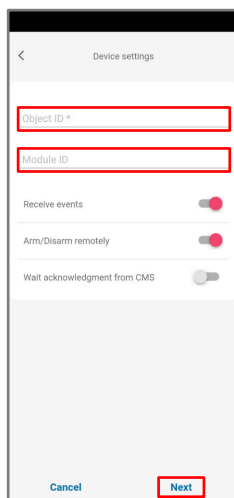

Enter "Object ID" and "Module ID". Press "NEXT"

Step 7

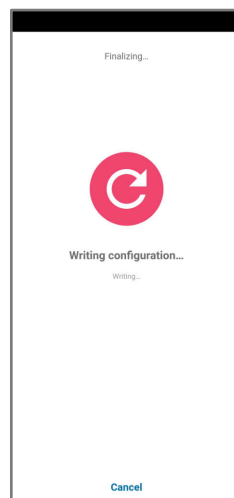

Wait while the configuration is written

Step 8

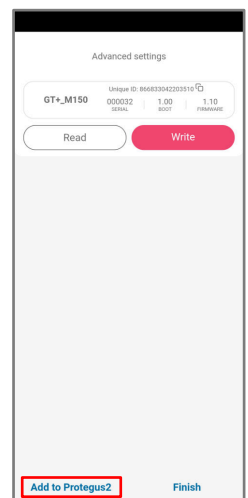

Press "Add to Protegus2"

Setting up the GT+ communicator with the app

Step 9

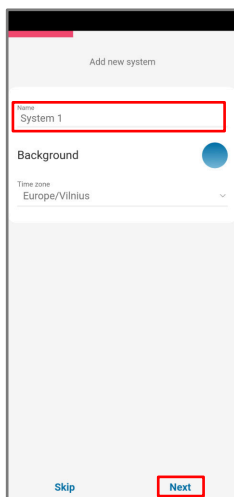

Enter system "Name".
Press "Next"

Step 10

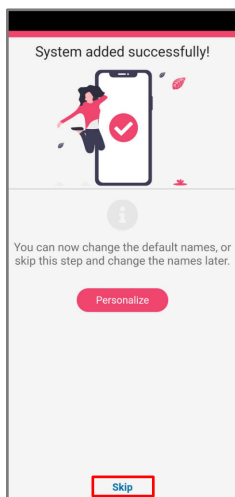

Press "Skip"

Step 11

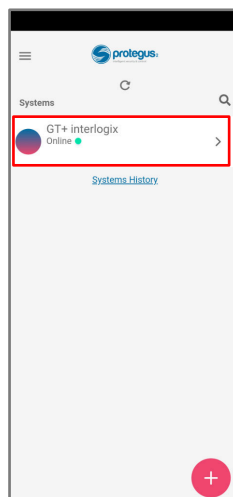

Press on system

Step 12

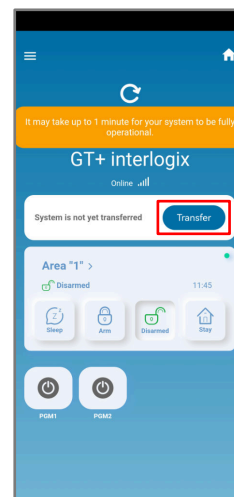

Wait 1 minute and press
"Transfer"

Step 13

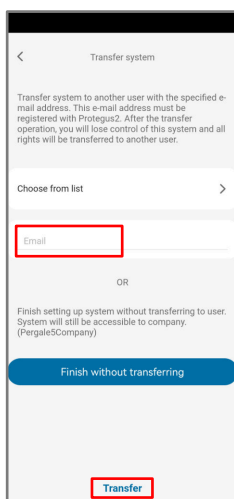

Enter the e-mail of the user
to whom the installer will
transfer the system. Press
"Transfer"

Step 14

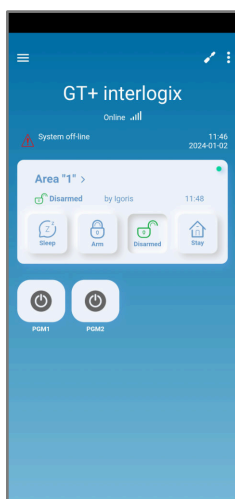

The system will appear in
Protegeus on the user's
phone

After completing the setup and installation perform a system check:

1. Create an event:
 - by arming/disarming the system with the control panel's keypad;
 - by triggering a zone alarm when the security system is armed.
2. Make sure that the event arrives to the CMS (Central Monitoring Station) and the Protegeus app.